

Features

- Industry Standard Architecture
Low Cost Easy-to-Use Software Tools
- High Speed Electrically Erasable Programmable Logic Devices
7.5 ns Maximum Pin-to-Pin Delay
- Several Power Saving Options

Device	I _{cc} , Stand-By	I _{cc} , Active
ATF22V10B	85 mA	90 mA
ATF22V10BQ	35 mA	40 mA
ATF22V10BL	5 mA	60 mA
ATF22V10BQL	5 mA	20 mA

- CMOS and TTL Compatible Inputs and Outputs
Input and I/O Pull-Up Resistors
- Advanced Flash Technology
Reprogrammable
100% Tested
- High Reliability CMOS Process
20 Year Data Retention
100 Erase/Write Cycles
2,000 V ESD Protection
200 mA Latchup Immunity
- Full Military, Commercial, and Industrial Temperature Ranges
- Dual-in-Line and Surface Mount Packages in Standard Pinouts

Logic Diagram

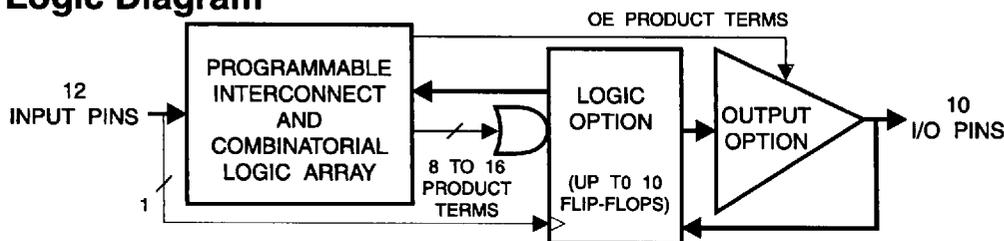

Description

The ATF22V10B is a high performance CMOS (Electrically Erasable) Programmable Logic Device (PLD) which utilizes Atmel's proven electrically erasable Flash memory technology. Speeds down to 7.5 ns and power dissipation as low as 10 mA are offered. All speed ranges are specified over the full 5 V ± 10% range for military and industrial temperature ranges, and 5 V ± 5% for commercial temperature ranges.

Pin Configurations

Pin Name	Function
CLK	Clock
IN	Logic Inputs
I/O	Bidirectional Buffers
*	No Internal Connection
VCC	+5 V Supply

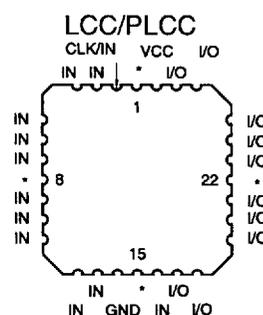
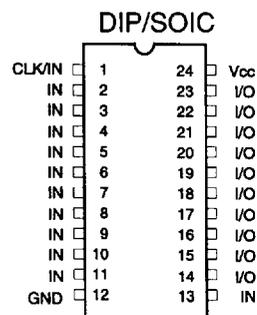

High
Performance
Flash PLD

ATF22V10B





Description (Continued)

Several low power options allow selection of the best solution for various types of power-limited applications. Each

of these options significantly reduces total system power and enhances system reliability.

Absolute Maximum Ratings*

Temperature Under Bias.....	-55°C to +125°C
Storage Temperature.....	-65°C to +150°C
Voltage on Any Pin with Respect to Ground.....	-2.0 V to +7.0 V ⁽¹⁾
Voltage on Input Pins with Respect to Ground During Programming.....	-2.0 V to +14.0 V ⁽¹⁾
Programming Voltage with Respect to Ground.....	-2.0 V to +14.0 V ⁽¹⁾

*NOTICE: Stresses beyond those listed under "Absolute Maximum Ratings" may cause permanent damage to the device. This is a stress rating only and functional operation of the device at these or any other conditions beyond those indicated in the operational sections of this specification is not implied. Exposure to absolute maximum rating conditions for extended periods may affect device reliability.

Note:

1. Minimum voltage is -0.6 V dc, which may undershoot to -2.0 V for pulses of less than 20 ns. Maximum output pin voltage is $V_{CC} + 0.75$ V dc, which may overshoot to 7.0 V for pulses of less than 20 ns.

D.C. and A.C. Operating Conditions

	Commercial	Industrial	Military
Operating Temperature (Case)	0°C - 70°C	-40°C - 85°C	-55°C - 125°C
V _{CC} Power Supply	5 V ± 5%	5 V ± 10%	5 V ± 10%

D.C. Characteristics

Symbol	Parameter	Condition	Min	Typ	Max	Units	
I_{IL}	Input or I/O Low Leakage Current	$0 \leq V_{IN} \leq V_{IL(MAX)}$		-35	-100	μA	
I_{IH}	Input or I/O High Leakage Current	$3.5 \leq V_{IN} \leq V_{CC}$			10	μA	
I_{CC}	Power Supply Current, Standby	$V_{CC} = MAX,$ $V_{IN} = MAX,$ Outputs Open	B-7, -10	Com.	85	120	mA
				Ind., Mil.	85	140	mA
			B-15, -25	Com.	85	120	mA
				Ind., Mil.	85	140	mA
			BQ-15	Com.	35	60	mA
			BL-15, BQL-25	Com.	5	10	mA
I_{CC2}	Clocked Power Supply Current	$V_{CC} = MAX,$ Outputs Open	BL-15, BQL-25	Com.	1		mA/MHz ⁽²⁾
				Ind., Mil.	1		mA/MHz ⁽²⁾
I_{CC3}	Clocked Power Supply Current	$V_{CC} = MAX,$ Outputs Open, $f = 15$ MHz	B-7, -10	Com.	90	120	mA
				Ind., Mil.	90	140	mA
			B-15, -25	Com.	90	120	mA
				Ind., Mil.	90	140	mA
			BQ-15	Com.	40	55	mA
			BL-15	Com.	60	90	mA
Ind., Mil.	60	130	mA				
BQL-25	Com.	20	50	mA			
	Ind., Mil.	20	70	mA			
$I_{OS}^{(1)}$	Output Short Circuit Current	$V_{OUT} = 0.5$ V			-130	mA	
V_{IL}	Input Low Voltage		-0.5		0.8	V	
V_{IH}	Input High Voltage		2.0		$V_{CC}+0.75$	V	
V_{OL}	Output Low Voltage	$V_{IN} = V_{IH}$ or $V_{IL},$ $V_{CC} = MIN$	$I_{OL} = 16$ mA	Com., Ind.		0.5	V
			$I_{OL} = 12$ mA	Mil.		0.5	V
V_{OH}	Output High Voltage	$V_{IN} = V_{IH}$ or $V_{IL},$ $V_{CC} = MIN$	$I_{OH} = -4.0$ mA	2.4		V	

- Notes: 1. Not more than one output at a time should be shorted. Duration of short circuit test should not exceed 30 sec.
2. Low frequency only. See Supply Current versus Input Frequency curves.



A.C. Waveforms ⁽¹⁾

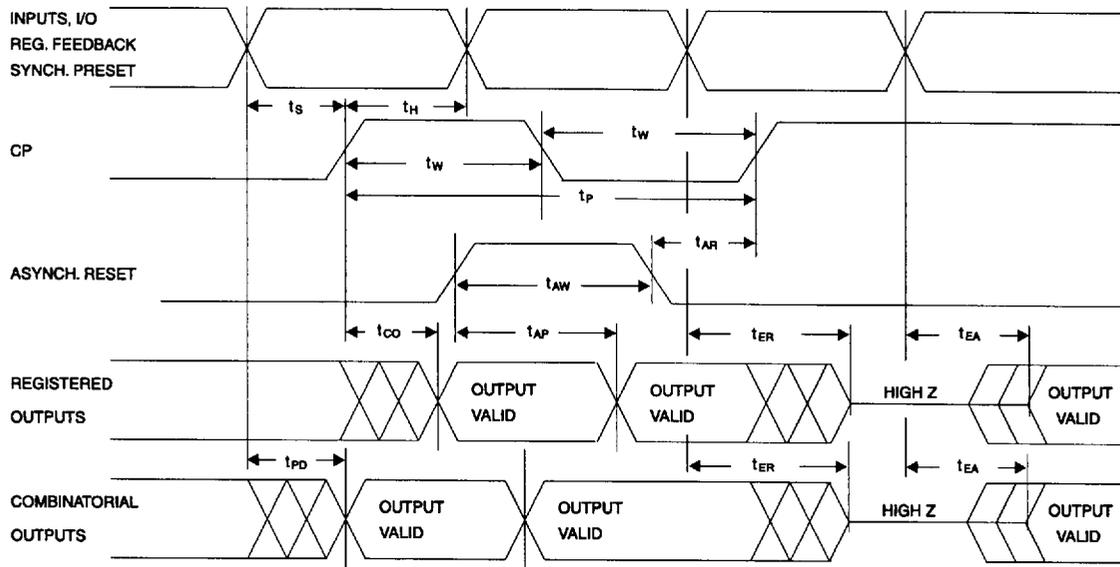

Note: 1. Timing measurement reference is 1.5 V. Input AC driving levels are 0.0 V and 3.0 V, unless otherwise specified.

A.C. Characteristics ⁽¹⁾

Symbol	Parameter	-7		-10		-15		-25		Units
		Min	Max	Min	Max	Min	Max	Min	Max	
t _{PD}	Input or Feedback to Combinatorial Output	3	7.5	3	10	3	15	3	25	ns
t _{CO}	Clock to Output	2	4.5 ⁽²⁾	2	6.5	2	8	2	15	ns
t _{CF}	Clock to Feedback		3.5		4		4.5		13	ns
t _S	Input or Feedback Setup Time	3.5		4.5		10		15		ns
t _H	Hold Time	0		0		0		0		ns
F _{MAX}	External Feedback 1/(t _S + t _{CO})	125 ⁽³⁾		90		55.5		33.3		MHz
	Internal Feedback 1/(t _S + t _{CF})	153		125		69		35.7		MHz
	No Feedback	166		166		83.3		38.5		MHz
t _P	Clock Period	6		8		12		26		ns
t _W	Clock Width	3		3		6		13		ns
t _{EA}	Input or I/O to Output Enable	3	7.5	3	10	3	15	3	25	ns
t _{ER}	Input or I/O to Output Disable	3	7.5	3	9	3	15	3	25	ns
t _{AP}	Input or I/O to Asynchronous Reset of Register	3	10	3	12	3	20	3	25	ns
t _{AW}	Asynchronous Reset Width	7		8		15		25		ns
t _{AR}	Asynchronous Reset Recovery Time	5		6		10		25		ns
t _{SP}	Setup Time, Synchronous Preset	4.5		6		10		15		ns
t _{SPR}	Synchronous Preset to Clock Recovery Time	5		8		10		15		ns

Note: 1. See ordering information for valid part numbers.
2. 5.5 nsec for DIP package devices.

3. 111 MHz for DIP package devices.

Input Test Waveforms and Measurement Levels

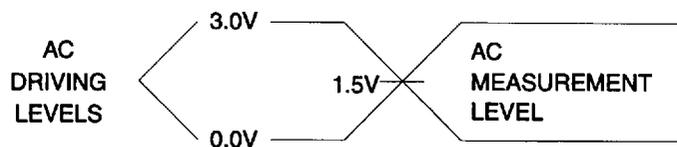

$t_R, t_F < 3 \text{ nsec}$

Output Test Loads:

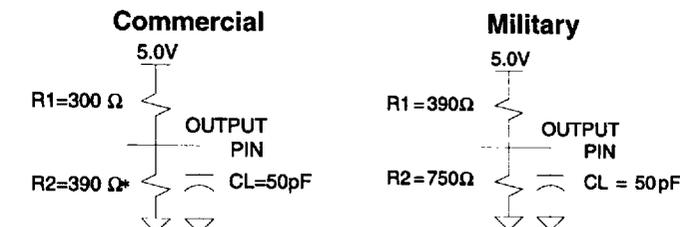

* All except -7 which is R2=300Ω

Pin Capacitance (f = 1 MHz, T = 25°C) ⁽¹⁾

	Typ	Max	Units	Conditions
C _{IN}	5	8	pF	V _{IN} = 0 V
C _{OUT}	6	8	pF	V _{OUT} = 0 V

Note: 1. Typical values for nominal supply voltage. This parameter is only sampled and is not 100% tested.

Power Up Reset

The registers in the ATF22V10Bs are designed to reset during power up. At a point delayed slightly from V_{CC} crossing V_{RST}, all registers will be reset to the low state. The output state will depend on the polarity of the output buffer.

This feature is critical for state machine initialization. However, due to the asynchronous nature of reset and the uncertainty of how V_{CC} actually rises in the system, the following conditions are required:

1. The V_{CC} rise must be monotonic,
2. After reset occurs, all input and feedback setup times must be met before driving the clock pin high, and
3. The clock must remain stable during t_{PR}.

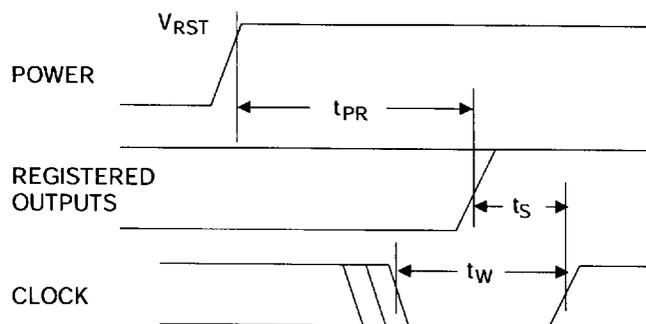

Parameter	Description	Typ	Max	Units
t _{PR}	Power-Up Reset Time	600	1,000	ns
V _{RST}	Power-Up Reset Voltage	3.8	4.5	V

Preload of Registered Outputs

The ATF22V10B's registers are provided with circuitry to allow loading of each register with either a high or a low. This feature will simplify testing since any state can be forced into the registers to control test sequencing. A JEDEC file with preload is generated when a source file with vectors is compiled. Once downloaded, the JEDEC file preload sequence will be done automatically by most of the approved programmers after the programming.

Security Fuse Usage

A single fuse is provided to prevent unauthorized copying of the ATF22V10B fuse patterns. Once programmed, fuse verify and preload are inhibited. However, the 64-bit User Signature remains accessible.

The security fuse should be programmed last, as its effect is immediate.



Electronic Signature Word

There are 64-bits of programmable memory that are always available to the user, even if the device is secured. These bits can be used for user-specific data.

Input and I/O Pull-Ups

All ATF22V10B family members have internal input and I/O pull-up resistors. Therefore, whenever inputs or I/Os are not being driven externally, they will float to V_{CC} . This ensures that all logic array inputs are at known states.

Input Diagram

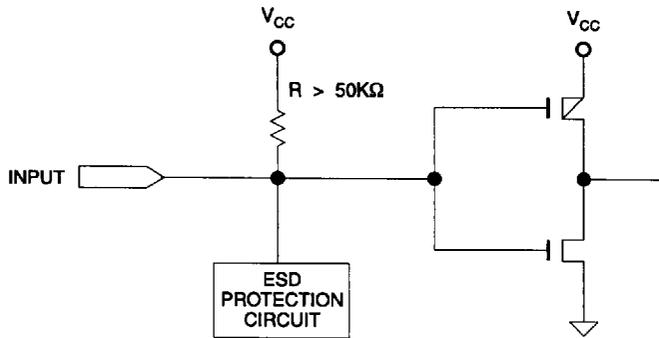

Programming/Erasing

Programming/erasing is performed using standard PLD programmers. See *CMOS PLD Programming Hardware & Software Support* for information on software/programming.

These are relatively weak active pull-ups that can easily be overdriven by TTL-compatible drivers (see input and I/O diagrams below).

I/O Diagram

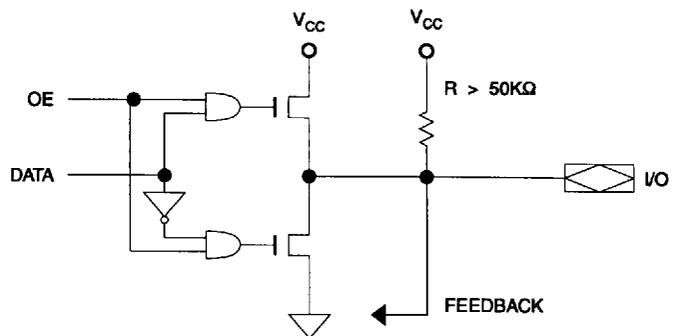

Functional Logic Diagram ATF22V10B

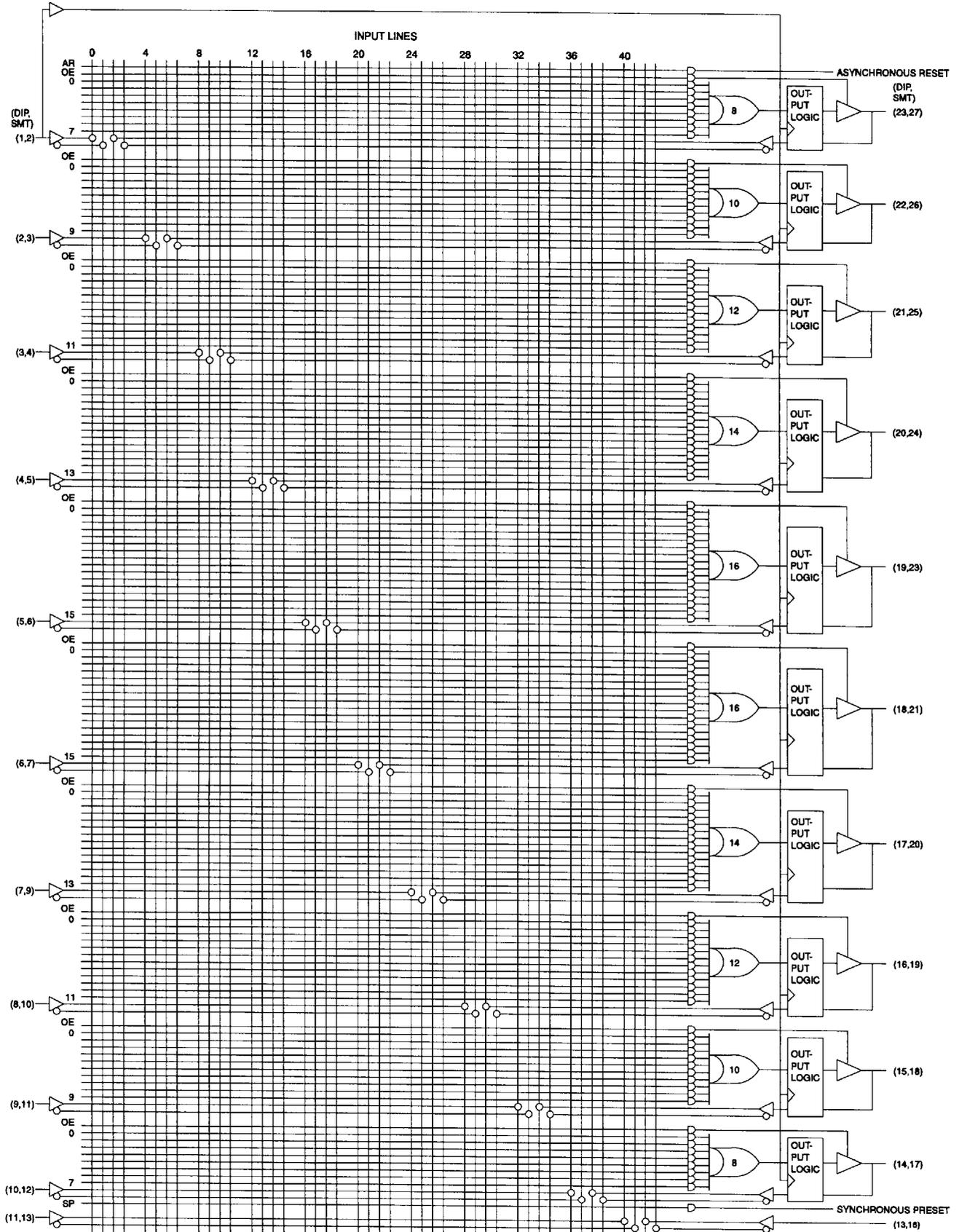



SUPPLY CURRENT vs. INPUT FREQUENCY
ATF22V10B/BQ (VCC = 5V, TA = 25C)

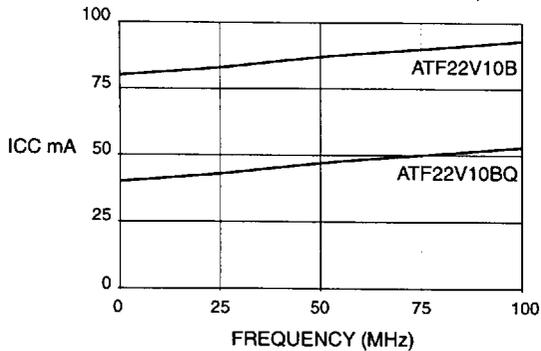

SUPPLY CURRENT vs. INPUT FREQUENCY
ATF22V10BL/BQL (VCC = 5V, TA = 25C)

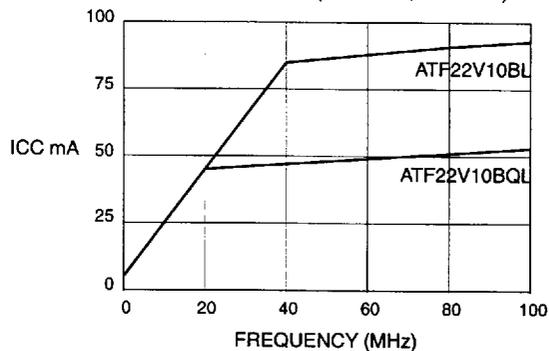

SUPPLY CURRENT vs. SUPPLY VOLTAGE
ATF22V10B/BQ (TA = 25C)

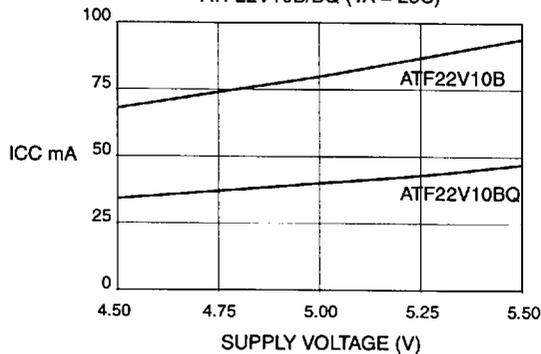

SUPPLY CURRENT vs. SUPPLY VOLTAGE
ATF22V10BL/BQL (TA = 25C)

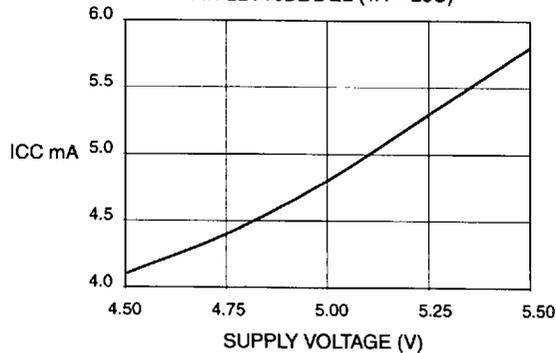

SUPPLY CURRENT vs. AMBIENT TEMPERATURE
ATF22V10B/BQ (VCC = 5V)

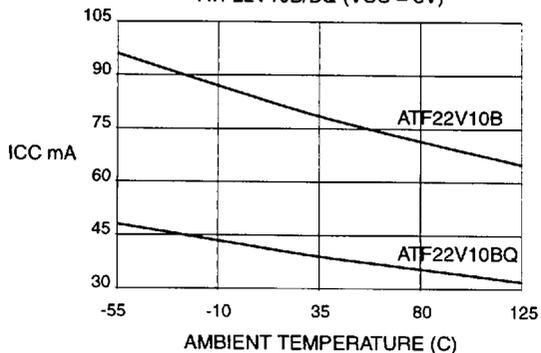

SUPPLY CURRENT vs. AMBIENT TEMPERATURE
ATF22V10BL/BQL (VCC = 5V)

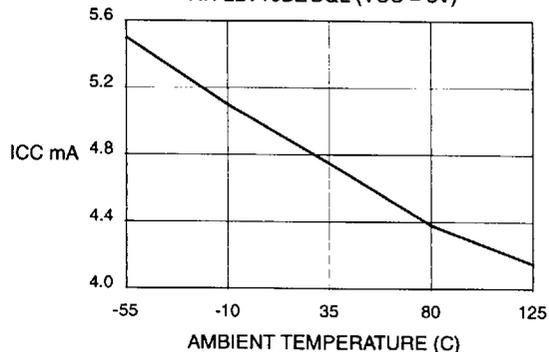

OUTPUT SOURCE CURRENT
vs. SUPPLY VOLTAGE (VOH = 2.4V)

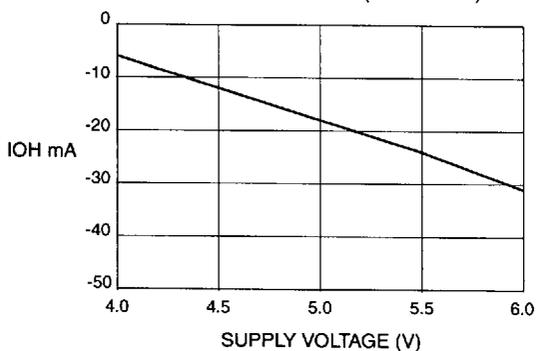

OUTPUT SINK CURRENT
vs. SUPPLY VOLTAGE (VOL = 0.5V)

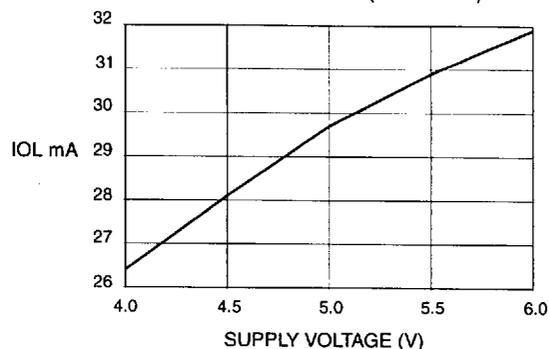

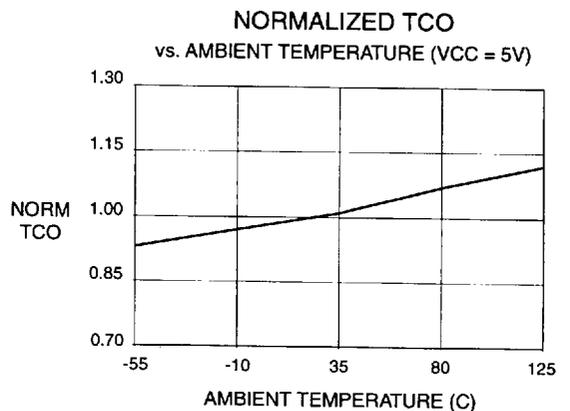
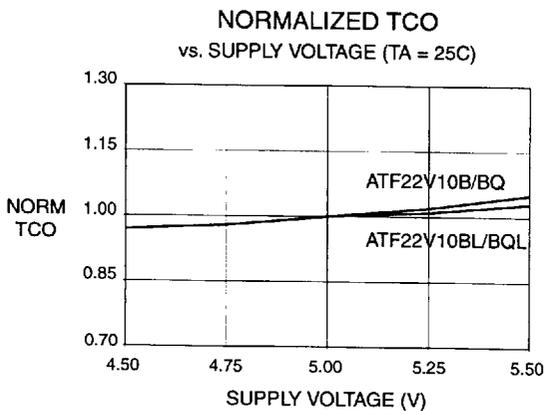
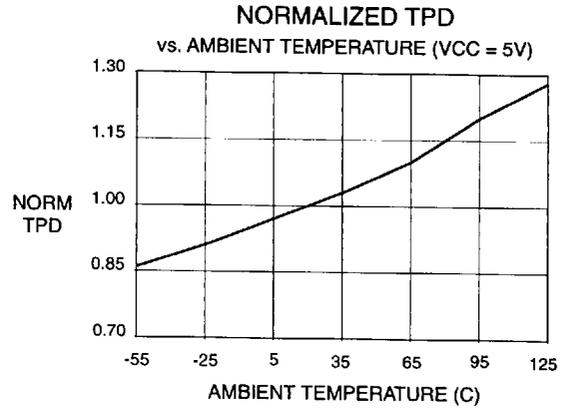
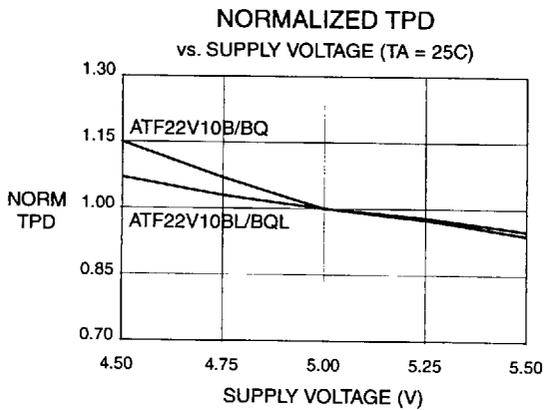
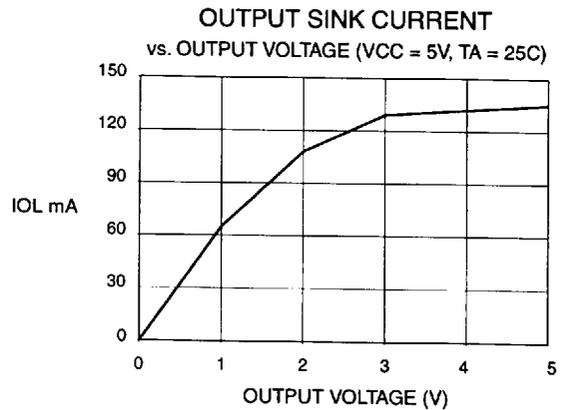
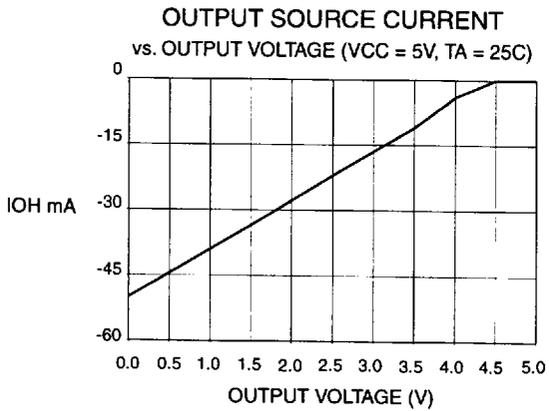
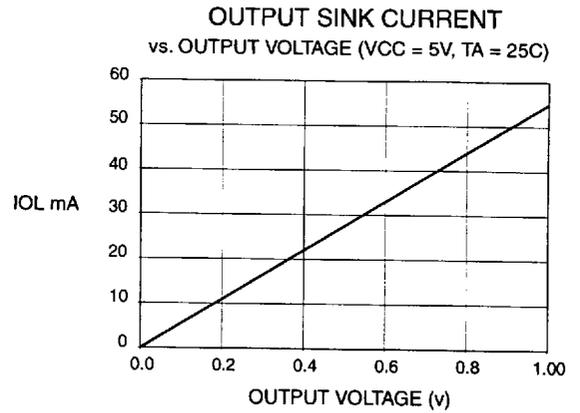
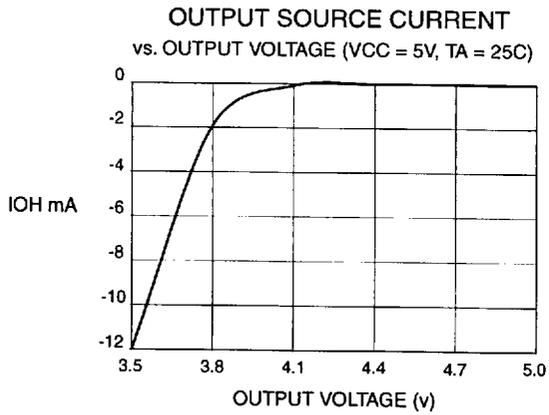

NORMALIZED TS
vs. SUPPLY VOLTAGE (TA = 25C)

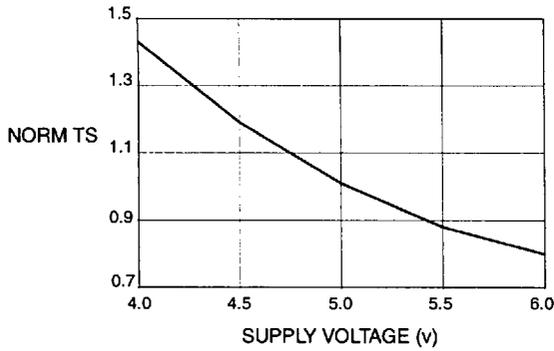

NORMALIZED TS
vs. AMBIENT TEMPERATURE (VCC = 5V)

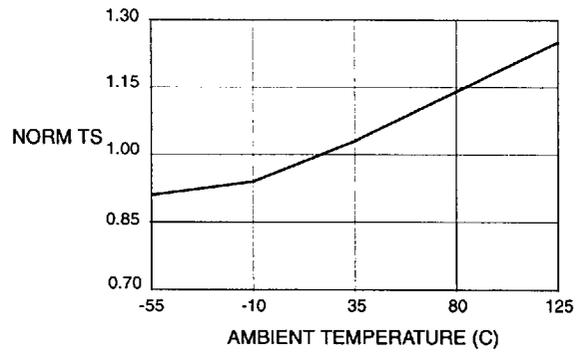

DELTA TPD vs. OUTPUT LOADING
(VCC = 4.5V, OUTPUT LOAD = COMMERCIAL)

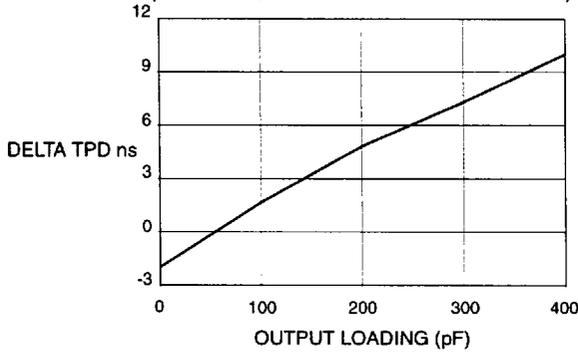

DELTA TCO vs. OUTPUT LOADING
(VCC = 4.5V, OUTPUT LOAD = COMMERCIAL)

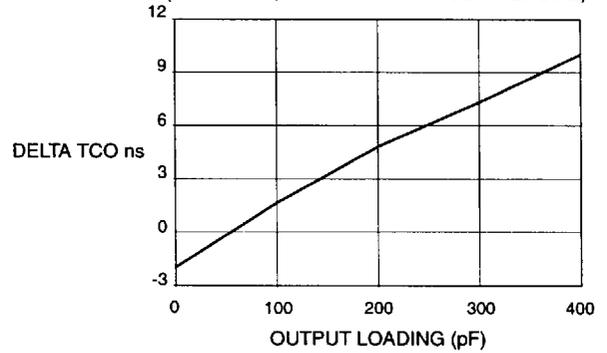

DELTA TPD vs. # OUTPUT SWITCHING
(VCC = 5V, TA = 25C)

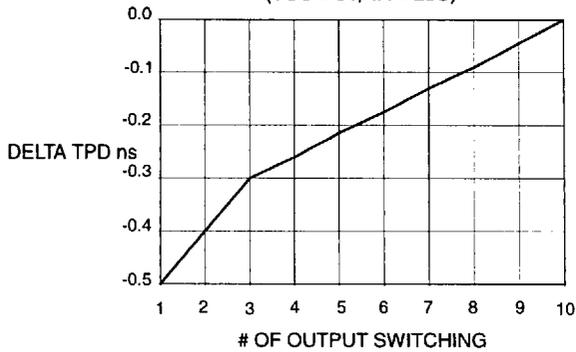

DELTA TCO vs. # OUTPUT SWITCHING
(VCC = 5V, TA = 25C)

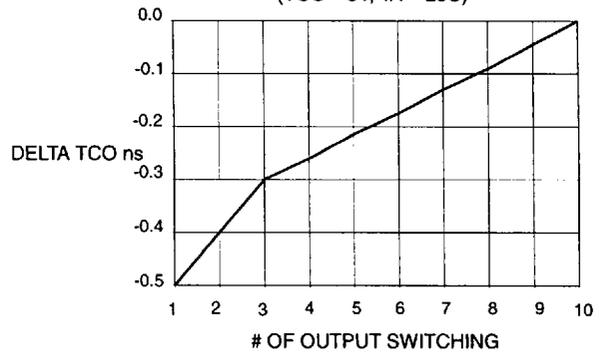

INPUT CURRENT vs. INPUT VOLTAGE
(VCC = 5V, TA = 25C)

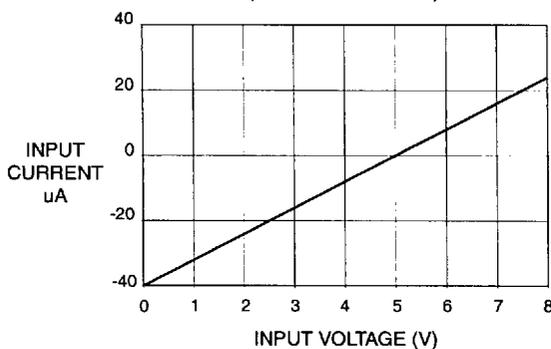

INPUT CLAMP CURRENT
vs. INPUT VOLTAGE (VCC = 5V, TA = 25C)

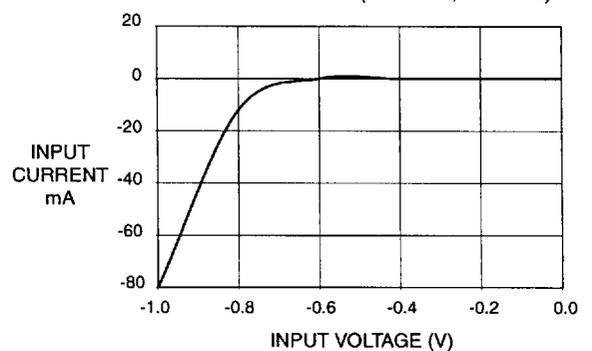

Ordering Information

tpD (ns)	ts (ns)	tCO (ns)	Ordering Code	Package	Operation Range
7.5	3.5	4.5	ATF22V10B-7JC ATF22V10B-7PC	28J 24P3	Commercial (0°C to 70°C)
10	4.5	6.5	ATF22V10B-10JC ATF22V10B-10PC ATF22V10B-10SC	28J 24P3 24S	Commercial (0°C to 70°C)
			ATF22V10B-10JI ATF22V10B-10PI ATF22V10B-10SI	28J 24P3 24S	Industrial (-40°C to 85°C)
			ATF22V10B-10GM/883 ATF22V10B-10NM/883	24D3 28L	Military/883C (-55°C to 125°C) Class B, Fully Compliant
15	10	8	ATF22V10B-15JC ATF22V10B-15PC ATF22V10B-15SC	28J 24P3 24S	Commercial (0°C to 70°C)
			ATF22V10B-15JI ATF22V10B-15PI ATF22V10B-15SI	28J 24P3 24S	Industrial (-40°C to 85°C)
			ATF22V10B-15GM/883 ATF22V10B-15NM/883	24D3 28L	Military/883C (-55°C to 125°C) Class B, Fully Compliant
25	15	15	ATF22V10B-25JC ATF22V10B-25PC ATF22V10B-25SC	28J 24P3 24S	Commercial (0°C to 70°C)
			ATF22V10B-25JI ATF22V10B-25PI ATF22V10B-25SI	28J 24P3 24S	Industrial (-40°C to 85°C)
10	4.5	6.5	5962-89841 06LA 5962-89841 063X	24D3 28L	Military (-55°C to 125°C) Class B, Fully Compliant
15	10	8	5962-89841 03LA 5962-89841 033X	24D3 28L	Military (-55°C to 125°C) Class B, Fully Compliant





Ordering Information

t _{PD} (ns)	t _s (ns)	t _{CO} (ns)	Ordering Code	Package	Operation Range
15	10	8	5962-89841 05LA 5962-89841 053X	24D3 28L	Military (-55°C to 125°C) Class B, Fully Compliant
25	15	15	5962-89841 04LA 5962-89841 043X	24D3 28L	Military (-55°C to 125°C) Class B, Fully Compliant
15	10	8	ATF22V10BL-15JC ATF22V10BL-15PC ATF22V10BL-15SC	28J 24P3 24S	Commercial (0°C to 70°C)
			ATF22V10BL-15JI ATF22V10BL-15PI ATF22V10BL-15SI	28J 24P3 24S	Industrial (-40°C to 85°C)
			ATF22V10BL-15GM/883 ATF22V10BL-15NM/883	24D3 28L	Military/883C (-55°C to 125°C) Class B, Fully Compliant
15	10	8	ATF22V10BQ-15JC ATF22V10BQ-15PC	28J 24P3	Commercial (0°C to 70°C)
25	15	15	ATF22V10BQL-25JC ATF22V10BQL-25PC ATF22V10BQL-25SC	28J 24P3 24S	Commercial (0°C to 70°C)
			ATF22V10BQL-25JI ATF22V10BQL-25PI ATF22V10BQL-25SI	28J 24P3 24S	Industrial (-40°C to 85°C)
			ATF22V10BQL-25GM/883 ATF22V10BQL-25NM/883	24D3 28L	Military/883C (-55°C to 125°C) Class B, Fully Compliant

Package Type	
24D3	24 Lead, 0.300" Wide, Ceramic Dual Inline Package (Cerdip)
28J	28 Lead, Plastic J-Leaded Chip Carrier (PLCC)
28L	28 Pad, Ceramic Leadless Chip Carrier (LCC)
24P3	24 Lead, 0.300" Wide, Plastic Dual Inline Package (PDIP)
24S	24 Lead, 0.300" Wide, Plastic Gull Wing Small Outline (SOIC)